

LSM Upgrade Kit



Compact FLIM and FCS Upgrade Kit for Laser Scanning Microscopes

- FLIM, FRET and FCS in one turn-key system
- **NEW** rapidFLIM the new and innovative method for ultra-fast FLIM imaging
- Compact, easy to use and maintenance-free kit, customized to all major LSMs in various configurations for unlimited flexibility
- Highest sensitivity with up to 4 detection channels
- Fluorescence lifetimes from < 100 ps up to μ s
- Advanced, user-friendly data analysis software with multiple analysis tools
- Options for anisotropy measurements and deep-tissue FLIM imaging



Applications

- Time-resolved fluorescence
- Fluorescence Lifetime Imaging (FLIM), **NEW** rapidFLIM
- Förster Resonance Energy Transfer (FRET)
- Fluorescence Correlation Spectroscopy (FCS, FLCS, FCCS)
- Pulsed Interleaved Excitation (PIE)
- Pattern matching analysis
- Anisotropy

Components

The complete kit to upgrade Laser Scanning Microscopes (LSMs) towards time-resolved measurements consists of a laser excitation system, single photon counting detector(s), TCSPC data acquisition unit and dedicated software to acquire and analyze the data. Optical fibers are used to couple the excitation light into the microscope and to guide the fluorescence emission to the detector. In order to perform 3D imaging, synchronization signals from the LSM controller are incorporated (line and frame clock).

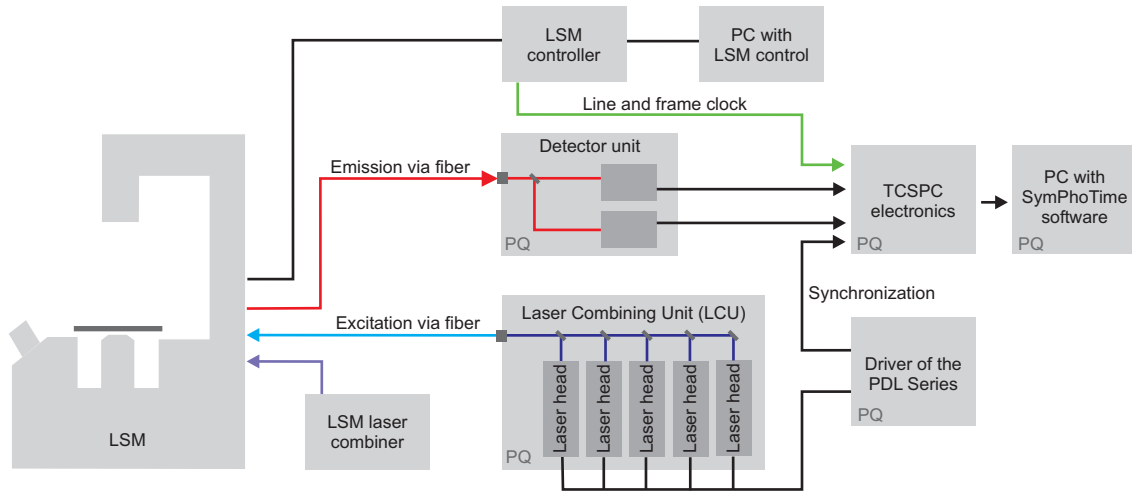

Excitation

The excitation subsystem consists of a pulsed diode laser driver and different laser heads with pulses in the picosecond time regime (cw mode is available as an option). The available wavelengths range from 375 nm to 900 nm. Up to five laser heads are integrated along with multiple optical components in a Laser Combining Unit (LCU) for easy handling and coupling into an optical fiber. In addition, Titanium:Sapphire lasers in multiphoton excitation set-ups can be integrated.



TCSPC data acquisition

The photon counting module (PicoHarp 300, TimeHarp 260, or HydraHarp 400) contains the complete timing electronics for Time-Correlated Single Photon Counting (TCSPC) with picosecond resolution. The versatile Time-Tagged Time-Resolved acquisition mode (TTTR) is used to study fluorescence dynamics and allows to synchronize the measurement with external events through special marker signals. These markers allow the reconstruction of 2D or 3D images. Furthermore, signals of up to 4 detectors can be recorded simultaneously.



Detectors

Three different detector types are available for the upgrade kit: Single Photon Avalanche Diodes, Photomultiplier Tubes or Hybrid Photomultiplier Tubes. The detectors differ in their efficiency, temporal resolution or active area. The choice of detectors depends on several factors such as the targeted application or interface to the microscope (descanned/non-descanned detection). Set-ups with up to 4 detector channels are available with integrated filter holders that allow quick change of emission filters in order to adapt to different experimental conditions. The non-descanned configuration is exclusively used for multiphoton excitation set-ups and allows, e.g., for deep-tissue FLIM.



Software

The SymPhoTime 64 software is based on the powerful but generic TTTR data format and features a clearly structured Graphical User Interface (GUI), which guides the user through all necessary steps for an individual analysis or measurement process. The software includes a wide range of analysis procedures ranging from e.g., Fluorescence Lifetime Imaging (FLIM) and Förster Resonance Energy Transfer (FRET) to pattern matching, Fluorescence (Cross) Correlation Spectroscopy (F(C)CS), Fluorescence Lifetime Correlation Spectroscopy (FLCS) and analysis of fluorescence time traces, bursts as well as lifetime histogramming. An integrated scripting language ("STUPSLANG 64") even enables the generation of new analysis procedures or to customize existing ones. The fast-FLIM image, TCSPC histogram as well as FCS auto- and crosscorrelation curves are already displayed online during data acquisition.

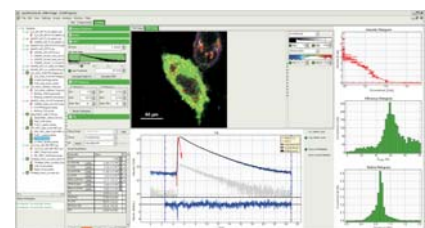

What is TCSPC?

Time-Correlated Single Photon Counting (TCSPC) is the most sensitive method to measure fluorescence lifetimes. The method is based on repetitive precise measurements of the time difference between the excitation (laser pulse) and the subsequent emission of a photon. As only a single photon is registered, the measurement is repeated very often and the measured start-stop-times are sorted into a histogram to determine the fluorescence lifetime.

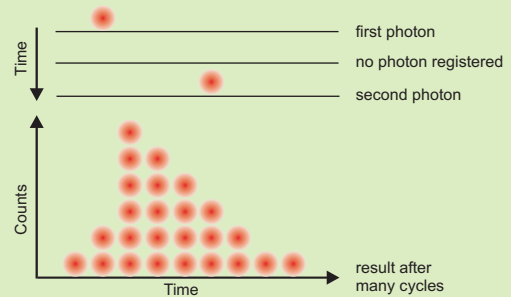

What is TTTR?

The prehistogramming in a typical TCSPC experiment prevents to study dynamic processes as molecular diffusion (FCS) or Fluorescence Lifetime Imaging (FLIM). This limitation is overcome by the unique Time-Tagged Time-Resolved (TTTR) measurement mode, wherein the measured time differences between the excitation pulse and the photon detection (start-stop times) are not sorted into a histogram, but stored directly along with an additional photon time that represents the arrival time of the photon with respect to the beginning of the experiment. As an additional feature, external marker signals or channel information can easily be integrated, leading to tremendous flexibility in measurement and analysis modes.

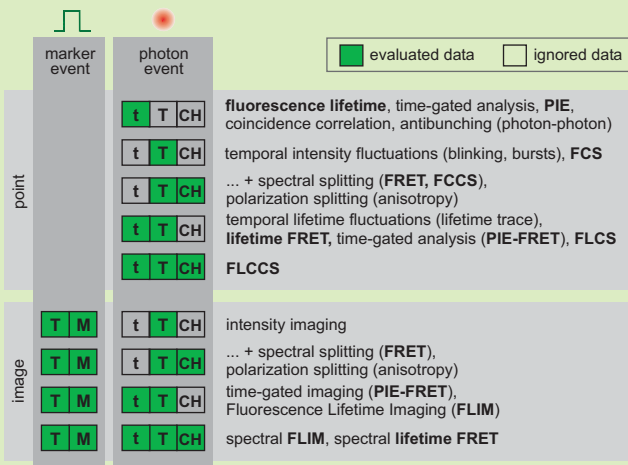
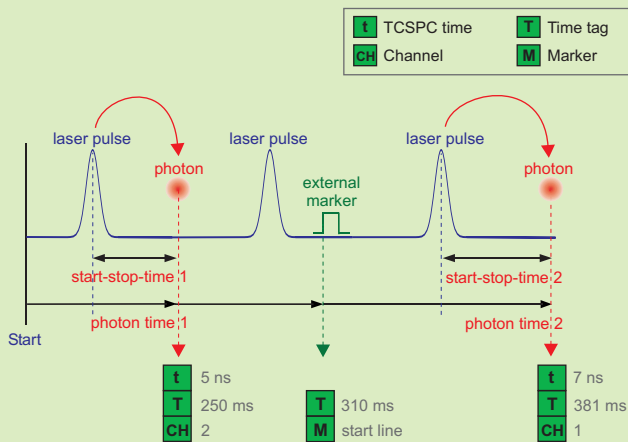

Measurement Examples

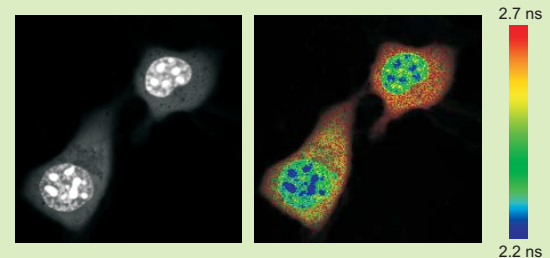

Interaction of protein partners in their natural environment can be studied via time-resolved FRET microscopy. This technique allows to characterize intra-nuclear dimer formation for the transcription factor C/EBP α , fused to the donor CFP and the acceptor YFP, respectively. The decreased fluorescence lifetime of the donor CFP-C/EBP delta 154 due to FRET is indicative for dimerization of the protein in the cell nucleus of living mouse pituitary GHFT1-5 cells. Excitation of the donor at 440 nm, detection around 470 nm.

(Sample courtesy of Ye Chen and Ammasi Periasamy, Keck Center for Cellular Imaging, University of Virginia)

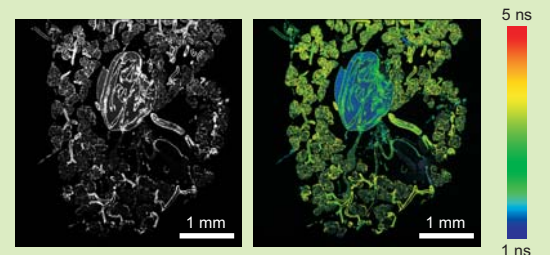

FLIM enables monitoring of ion concentrations in insect organs. Cockroach salivary glands, a well-established model system for studying epithelial ion transport, were stained with the Cl⁻ sensitive dye MQAE. This dye is quenched by chloride ions leading to a shortened fluorescence lifetime. Recording FLIM images allows mapping of Cl⁻ concentration throughout the salivary system. Excitation at 750 nm (two-photon exc.), detection between 420 nm and 680 nm.

(In collaboration with C. Dosche and C. Hille, Potsdam University, Germany)

Specifications

Excitation Source ^{1,2}

| | |
|-----------------------------|--|
| Light source ^{3,4} | Picosecond Laser Diode Heads |
| Wavelengths | 405-640 nm, Solea supercontinuum laser |
| Repetition rate | up to 40 MHz (optional 80 MHz) |
| Pulse width | down to 70 ps (FWHM) |

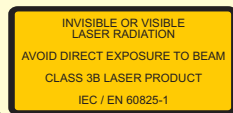

Detectors

| | | | | |
|--|--------------|------------------|-------------------|------------------|
| Type ¹ | Hybrid PMT | SPAD (SPCM-AQRH) | SPAD (PDM Series) | PMT (PMA Series) |
| Spectral range | 300-720 nm | 400-1000 nm | 400-1000 nm | 185-820 nm |
| Dark counts (at 20 °C, typ. value) | 300-1000 cps | < 100 cps | < 250 cps | < 900 cps |
| Instrument Response Function (IRF at 650 nm) | typ. 120 ps | typ. 200 ps | typ. 50 ps | typ. 200 ps |

TCSPC Data Acquisition

| | | |
|------------------------------|---|---|
| Type | PicoHarp 300 | HydraHarp 400 |
| Number of detection channels | 4 | up to 8 |
| Time resolution (bin width) | 4 ps | 1 ps |
| Dead time | < 95 ns | < 80 ns |
| Interface | USB 2.0 | USB 3.0 |
| Sustained data throughput | up to 5 million counts/second | up to 40 million counts/second |
| Maximum collection time | virtually unlimited, restricted only by computer memory/harddisk capacity | virtually unlimited, restricted only by computer memory/harddisk capacity |

| | | |
|------------------------------|---|---|
| Type | TimeHarp 260 NANO | TimeHarp 260 PICO + long range mode |
| Number of detection channels | 2 | 2 |
| Time resolution (bin width) | 250 ps | 25 ps/2.5 ns |
| Dead time | < 2 ns | < 25 ns/< 2.5 ns |
| Interface | PCIe 1.1x1 | PCIe 1.1x1 |
| Sustained data throughput | up to 40 million counts/second | up to 40 million counts/second |
| Maximum collection time | virtually unlimited, restricted only by computer memory/harddisk capacity | virtually unlimited, restricted only by computer memory/harddisk capacity |

Software Features ⁴

| | |
|--------------------------------------|--|
| General concept | 64 bit operation system, versatile TTTR file format for data acquisition and analysis, time gating for all methods, Graphical User Interface (GUI) for automated analysis and measurement processes, automated routines for many measurements and standard analysis procedures |
| Point measurements | MCS trace, FCS, FCCS, FLCS, PIE-FCS calculation and fitting, TCSPC histogram, on/off-state histogram, burst size analysis, BIFL (Burst Integrated Analysis), (PIE-)FRET histogram, particle brightness analysis, lifetime histogram, total correlation and coincidence correlation histograms (antibunching) |
| Fluorescence Lifetime Imaging (FLIM) | (Time-gated) Fluorescence Intensity Imaging; Fluorescence Lifetime Imaging (FLIM); Fluorescence lifetime histogram; time-gated analysis; TCSPC histogram for region of interest; FLIM-FRET image analysis incl. FRET efficiency, FRET Radius and Amplitude ratio; Intensity FRET; Bleedthrough Correction; Pattern Matching; steady-state anisotropy |
| Power requirements | 110/230 V, 50/60 Hz |

Supported LSMs ⁵

| | |
|---------|---|
| Leica | TCS SP8, SP5 |
| Nikon | A1, C2+, C1si |
| Olympus | FluoView FV3000, FV1200 (MPE), FVMPE-RS, FV1000 (MPE) |
| Zeiss | LSM 880, LSM 780, LSM 710 |

1) Other laser lines or detector types available upon request.
 2) Multiphoton (Ti:Sapphire) lasers can be implemented as well.
 3) Class 3B lasers - will increase the classification of your LSM accordingly.
 4) For details please see our SymPhoTime 64 brochure.
 5) Upgrades of other LSM types are also possible, please contact us for details.

All Information given here is reliable to our best knowledge. However, no responsibility is assumed for possible inaccuracies or omissions. Specifications and external appearances are subject to change without notice. Trademarks or corporate names are used for explanation and identification, to the owner's benefit and without intent to infringe.

© PicoQuant GmbH, October 2016



PicoQuant GmbH
 Rudower Chaussee 29 (IGZ)
 12489 Berlin
 Germany

Phone +49-(0)30-6392-6929
 Telefax +49-(0)30-6392-6561
 Email info@picoquant.com
 WWW http://www.picoquant.com